

Tactical Public Realm Guidelines

August 2018



*They are natural break-out spots in business districts,
and along the business edges of the street
fill areas of the city with businesses,
generating opportunity for urban jobs.*

*The brown weeds of the grass up to me
Tumbled down from the bottom of the street,
And saw I was a passerby with empty skin
As afternoon suns that heave in the air
And vanishes along the level of the road.*

Tactical Public Realm

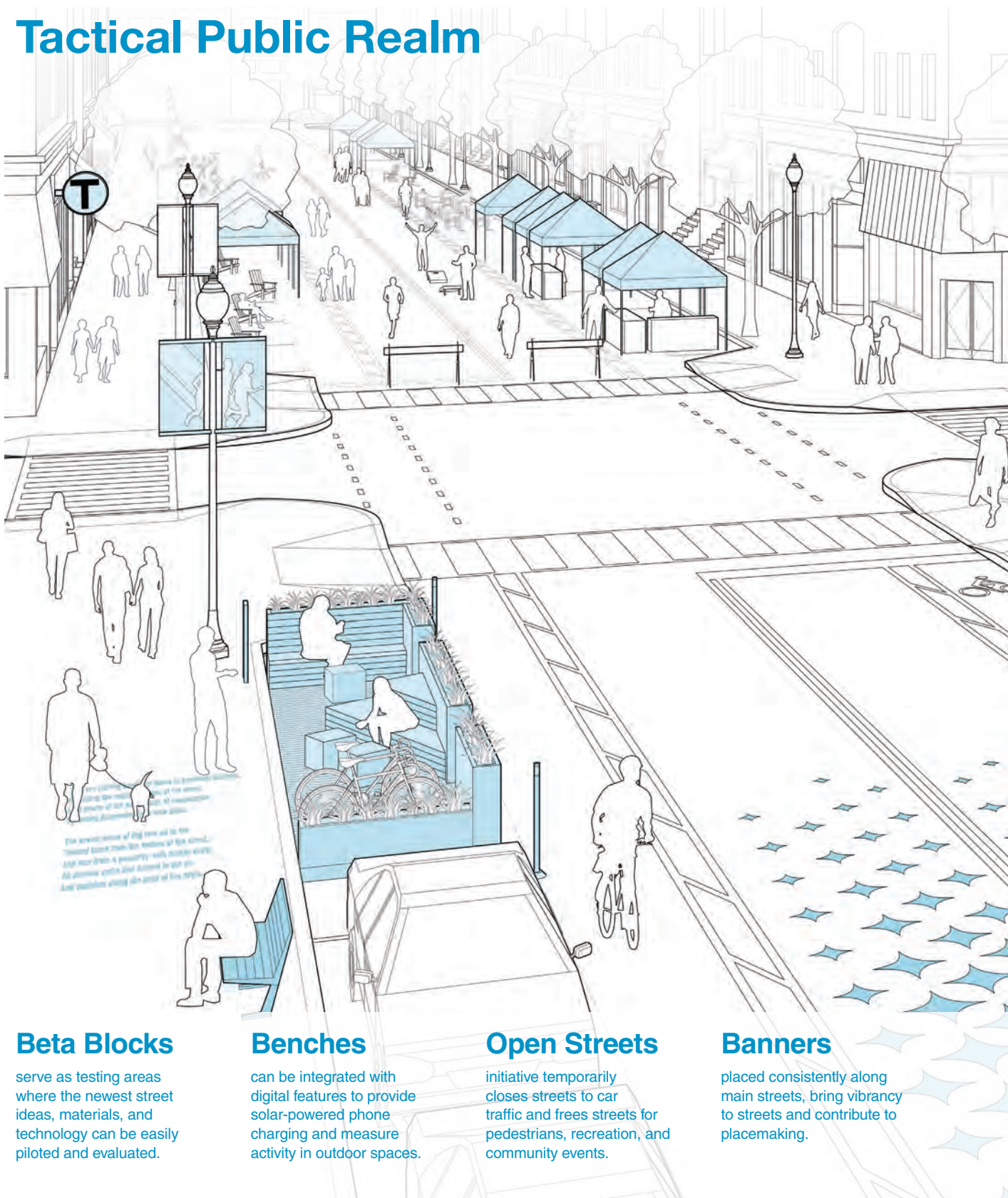

The placement of the tree will be determined based on the location of the street. All projects will be subject to the city's tree ordinance and other applicable regulations.

Beta Blocks

serve as testing areas where the newest street ideas, materials, and technology can be easily piloted and evaluated.

Benches

can be integrated with digital features to provide solar-powered phone charging and measure activity in outdoor spaces.

Open Streets

initiative temporarily closes streets to car traffic and frees streets for pedestrians, recreation, and community events.

Banners

placed consistently along main streets, bring vibrancy to streets and contribute to placemaking.

Temporary Art

activates public spaces with physical installations and performances by local residents and artists.

Paint Box

celebrates local artists by bringing their original designs to utility boxes.

Public Space Invitational

challenges designers, artists, and engineers to reimagine Boston's public spaces.

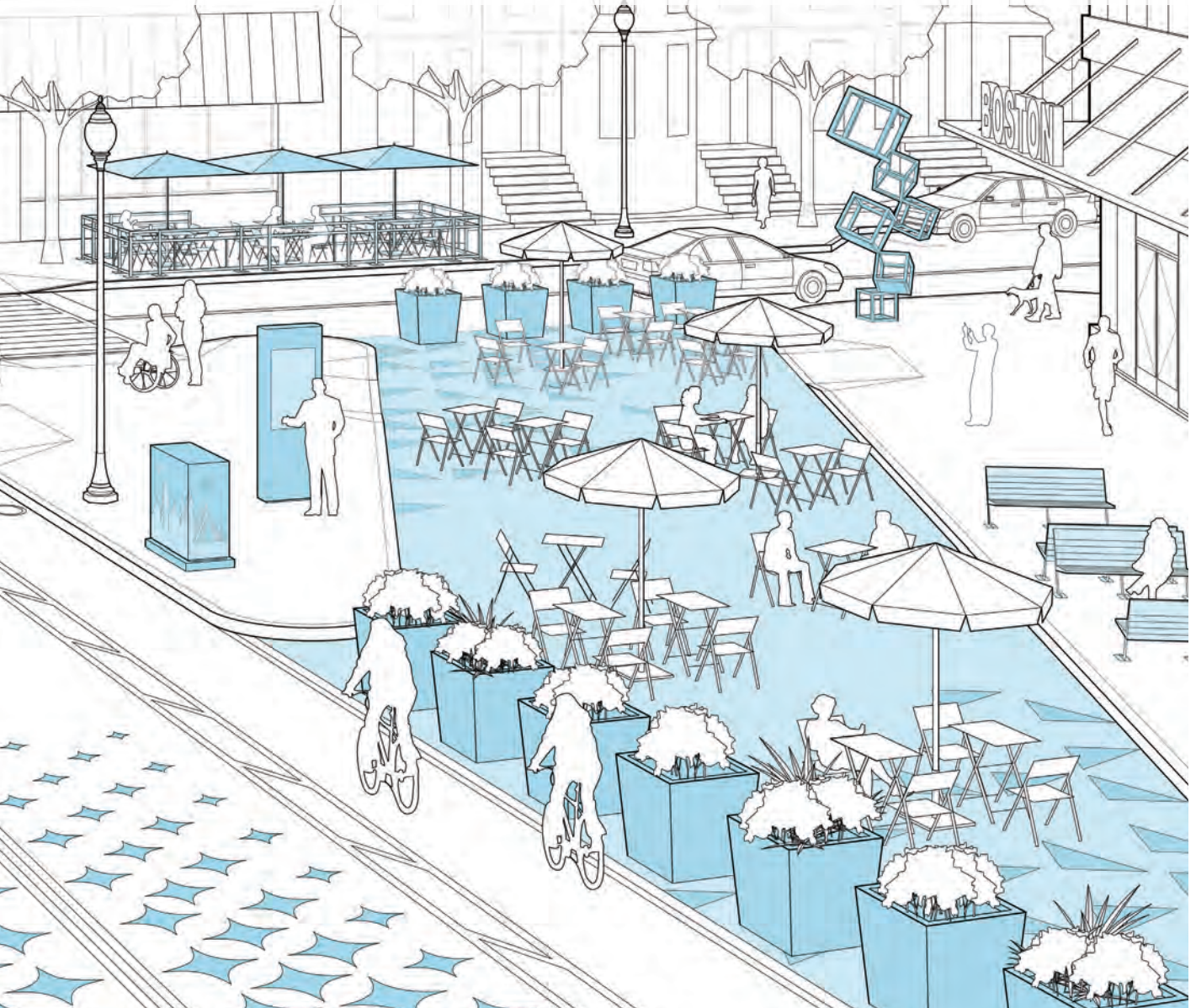

Tactical Plazas

transform underutilized pavement and irregular intersections into pedestrian only gathering spaces.

Parklets

repurpose on-street parking spots into public spaces for socializing and gathering.

Outdoor Cafes

add activity to the street and seasonally expand spaces for businesses and patrons.

Temporary Art: Street Murals

incorporate the creativity of local residents and artists to convert streets into public art installations.





Introduction 3

Tactical Plazas 5

Parklets 13

Outdoor Cafes 21

**Temporary Art:
Street Murals 31**

Acknowledgments

These tactical public realm guidelines were developed as an early-action recommendation from the City's 2017 citywide mobility plan, Go Boston 2030, in a unique collaboration between the City of Boston, A Better City, and the Barr Foundation. Collaborations such as these advance the City's efforts to make our streets not only more functional, but also, more delightful.

 Mayor Martin J. Walsh
City of Boston



A Better City is a diverse group of business leaders united around a common goal—to enhance Boston's and the region's economic health, competitiveness, vibrancy, sustainability and quality of life. By amplifying the voice of the business community through collaboration and consensus across a broad range of stakeholders, A Better City develops solutions and influences policy in three critical areas central to the Boston region's economic competitiveness and growth: transportation and infrastructure, land use and development, and energy and environment.



Based in Boston, the Barr Foundation works in partnership with nonprofits, foundations, the public sector, and civic and business leaders to elevate the arts and creative expression, to advance solutions for climate change, and to connect all students to success in high school and beyond. Founded in 1997, Barr now has assets of \$1.7 billion, and has contributed more than \$838 million to charitable causes.

To view this report online,
go to <http://www.boston.gov/publicrealm>.



City of Boston Public Realm Working Group

Boston Public Works Department
Boston Transportation Department
Boston Planning and Development Agency
Boston Parks and Recreation Department
Boston Department of Innovation and Technology
Mayor's Commission for Persons with Disabilities
Mayor's Office of New Urban Mechanics
Mayor's Youth Council
Mayor's Office of Arts and Culture
Mayor's Environment, Energy and Open Space
Mayor's Office of Neighborhood Services

Chris Osgood, Chief of Streets, Transportation, and Sanitation
Gina N. Fiandaca, Commissioner, Boston Transportation Department

Publication Team

A Better City
Irene Figueroa-Ortiz

Boston Transportation Department
Vineet Gupta

Utile, Inc.
Tim Love
Jessica Robertson
Joshua Simoneau
Andrew Nahmias

Introduction

Improving the public realm was identified as a top priority by the community engagement process of Go Boston 2030, the citywide mobility plan completed in 2017. The process also highlighted a need for new short- and long-term public space strategies to reclaim underutilized transportation infrastructure in our neighborhoods. In response to these placemaking aspirations, Go Boston 2030 called for a Public Realm Plan to identify, celebrate, and leverage placemaking opportunities in our street network. The key goals and aspirational targets outlined for the Public Realm Plan were focused on increasing accessibility to multi-modal transportation in all neighborhoods, eliminating traffic fatalities and severe injuries on our streets, and improving the commuter’s experience of Boston’s street network.

These guidelines build on previous and ongoing efforts by the City of Boston to improve the functionality and quality of experience of our streets. In 2013, the Boston Transportation Department released Boston Complete Streets, a set of best practices and urban design guidelines for creating multi-modal, shared streets.

In addition to major capital projects, there are opportunities for “tactical” interventions that can transform the public realm through lower-cost, rapid implementation. These guidelines serve to introduce new tools for tactical public realm improvements into the City’s toolkit for public space development and management.

The City’s understanding of the role of the street has been shifting. Rather than just serving vehicles as transportation networks, our streets can be spaces in which to convene, create, and experiment. The enhanced roles streets can play include:

Streets as Living Rooms: the “third spaces” where communities are forged. Placemaking strategies that create the infrastructure for these meaningful interactions include tactical plazas, parklets, open streets, and sidewalk cafes.

Streets as Canvasses: a place for creative expression. Programs that enable these activities include Street Murals, Temporary Art, and Paint Box.

Streets as Experiments: public spaces where new technologies are tested and integrated into the built environment. The New Urban Mechanics’ Public Space Invitational, the Kiosk Program, and the Soofa bench initiative are examples of how placemaking can provide space for experimentation.

This publication focuses on introducing tactical placemaking guidelines and updated city processes for the creation of Tactical Plazas, Parklets, Outdoor Cafes, and Street Murals along Boston’s streets.





Tactical Plazas



TACTICAL PLAZAS

Overview

Boston's unique charm stems in part from its dense network of sometimes irregular streets. These streets were once a chaotic mix of pedestrians, carriages, trolleys, and bicycles. Throughout the 20th century, street infrastructure was shaped to segregate different users, and most of the space was given over to automobiles. In dense neighborhoods of Boston, pedestrian space is often limited to narrow sidewalks, with relatively few opportunities for outdoor gathering spaces. At the same time, some of Boston's many irregular intersections and blocks harbor more pavement than is needed for safe traffic movements. Boston has joined a growing number of cities taking advantage of these areas of superfluous pavement, and is turning them into public plazas and parks.

Tactical Plazas are public open spaces that are created out of underutilized space on city streets. They can quickly transform barren pavement into a lively place to gather, improving safety and setting the stage for the construction of a permanent plaza.

A few simple components can transform a barren stretch of pavement into an attractive place for people to gather. The most important elements are surface paint and perimeter planters to delineate the space clearly, and seating, so that people passing by will be encouraged to linger. This section will review each element in detail.

Tactical Plazas are a partnership between the City and neighborhood groups, small business organizations, or major property owners. Although successful plazas have active community partners, they are public spaces that are open to all and not licensed to specific businesses.

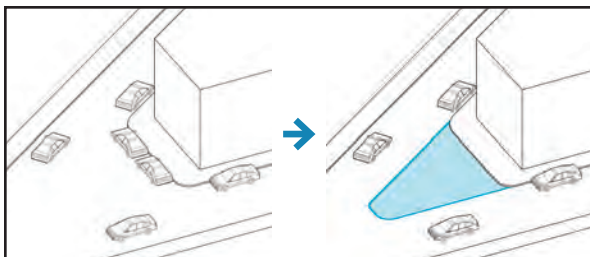

Furniture

Providing ample open seating is crucial to the success of a plaza. Different types of furniture are most appropriate for different locations, depending on the level of maintenance and the adjacent uses. Five percent of seating must be accessible for persons with disabilities.

Perimeter Barriers

Planters or equivalent barriers provide a vertical barrier between the plaza and the roadway, while helping to define the space. Rectangular planters or bollards are preferred and must weigh a minimum of 200lbs.

Traffic Control Devices

Flexible, surface-mounted, reflective bollards are installed at the edges of the plaza to increase visibility for motorists while accommodating drainage. In addition 8"-12" wide cane-detectable perimeter temporary curb marks the boundaries of the plaza.

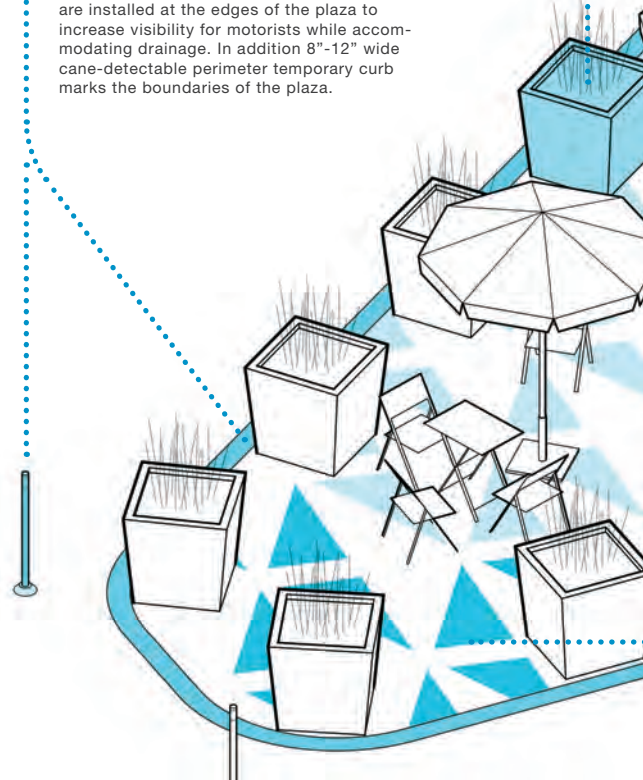

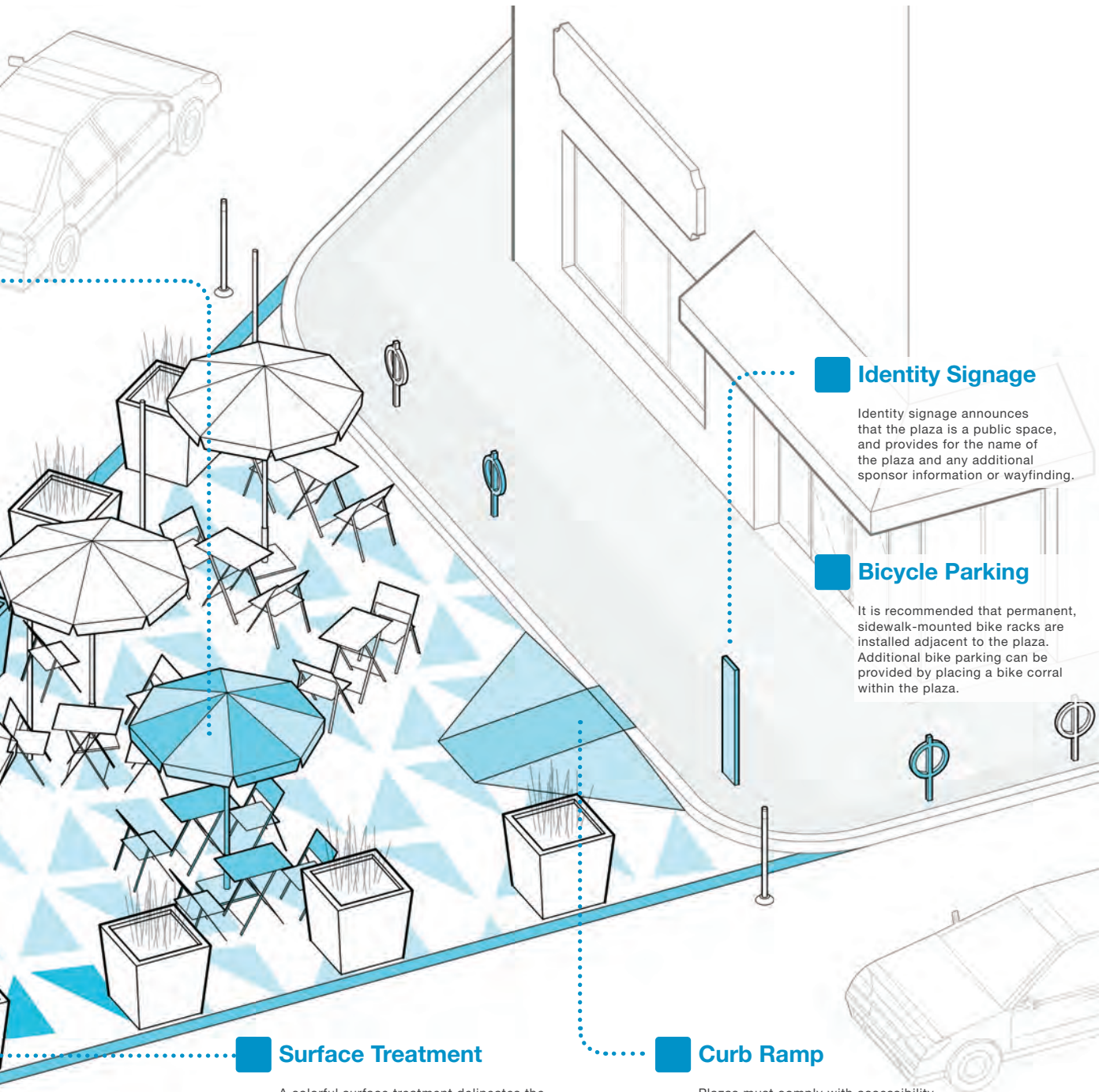

Identity Signage

Identity signage announces that the plaza is a public space, and provides for the name of the plaza and any additional sponsor information or wayfinding.

Bicycle Parking

It is recommended that permanent, sidewalk-mounted bike racks are installed adjacent to the plaza. Additional bike parking can be provided by placing a bike corral within the plaza.

Surface Treatment

A colorful surface treatment delineates the pedestrian zone and brands the plaza.

Curb Ramp

Plazas must comply with accessibility standards and allowable slopes. If there are no existing curb ramps that provide access to the plaza, a semi-permanent ramp must be installed.

Context and Location Criteria

Tactical plazas can be transformational in many different contexts. The best locations are places where there is not only excess pavement, but also, a demand for new public open space. Downtown neighborhoods often lack open space, and have a high density of businesses—both conditions that can help increase utilization of a new plaza.

Mixed-use areas in neighborhoods, such as one of Boston's Main Street Districts, can be good locations for plazas, as well. Proximity of restaurants and retail businesses can help increase use of a plaza, and in turn, the plaza can help draw more foot traffic for businesses.

In residential neighborhoods without much public open space, especially denser areas where residents do not have private yards, a plaza can provide a welcome gathering space. Plazas can also help calm traffic, which is a priority in many neighborhoods.

General Requirements

Speed Limit	Plazas are permitted on streets regulated at or below the default speed limit of 25 mph.
Size	Plazas must occupy a minimum of 1,000 square feet.
Access	Seating in a plaza may not be licensed to an individual establishment.
Emergency Access	Alternate access must be provided for emergency vehicles. Plazas must not block access to fire hydrants.
Loading	Alternate access must be provided for delivery trucks and sanitation vehicles.
Utility Access	Manhole covers and other utilities are allowed within plazas, but cannot be blocked by furniture.
Clearance	Adequate clearance must be provided for turning in and out of nearby driveways.
Traffic Flow	Existing traffic volumes must be maintained. Plazas must not interfere with existing public-transit routes.
Paving Schedule	Plazas should not be installed in locations scheduled for resurfacing or utility work within 8 months of installation.



Above: Underutilized areas of Boston streets that are well suited to becoming Tactical Plazas

Closing Redundant Streets



Squaring a Corner



Diagonal Intersecting with Grid



Filling in Redundant Lanes



Application and Implementation Process

Each year, the City may fund one to two Tactical Plazas selected by a public nomination process. Additional Plazas may be implemented if fully funded by community partners. The process for privately-funded Plazas is the same, except that the partner must provide their own design consultant and contractor.

The Tactical Plaza Program will follow the process outlined below, with specific roles identified for Plaza Partners.

1 Nominate a location for a Tactical Plaza and submit application to Boston Transportation Department (BTD)

Application guidelines can be found at www.boston.gov/publicrealm.

Applications are accepted annually from November 15 through February 15, and must include:

- ▶ street-level photos of the site to describe its existing conditions and an aerial image diagram to indicate the proposed Plaza location
- ▶ letters of support from abutters and local organizations such as resident associations and business groups

2 Initial review by the City

Applications will be evaluated by the City and selected based on criteria (www.boston.gov/publicrealm).

3 The City's on-call design consultant will work with the community partner to design the Tactical Plaza

- ▶ Applicant should expect to meet with BTD and the City's on-call consultant up to three times.
- ▶ Applicant is strongly encouraged to work with local artists and designers to develop concepts that incorporate art.

4 Proposal will be reviewed through a public process determined by the City and adjusted based on the feedback

5 The City's on-call design consultant presents to Public Improvement Commission (PIC) for administrative approval

6 Memorandum of Understanding (MOU)

Successful applicant becomes the official Plaza Partner by signing an MOU with the Public Improvement Commission (PIC). Sample available at www.boston.gov/publicrealm.

7 Design installed by City contractor

Plazas will be in place year round for up to three years. Furniture may be stored during winter.

Community Partner and City Roles

The City has committed to assist the funding and implementation of Tactical Plazas. However, the long-term success of the Plazas will depend on community partners. Successful Tactical Plazas are embraced by those who use them, and are supported by community partners that provide “eyes on the Plaza” and have a true sense of ownership.

Plaza Partner

Regular Maintenance

- ▶ Cleaning, trash removal, furniture maintenance, and plant watering are the responsibility of the Plaza Partner.

Day-to-Day Management

- ▶ Daily setup and breakdown of any items that cannot be left out overnight, such as games, are the responsibility of the Plaza Partner.
- ▶ Selection of plaza furnishings should take into consideration the level of daily management required.

Winter Maintenance

- ▶ Leaving the plaza snowed in is acceptable as long as it does not inhibit access through the intersection for all users. Furniture may be removed, and shoveling is the responsibility of the Plaza Partner.

City

- ▶ The City is responsible for maintaining the temporary curb.
- ▶ The City is responsible for any necessary replanting or repair/replacement of furniture, perimeter, and bollards/planters.
- ▶ Maintenance of the pavement in the case of utility work or pavement repairs will be the responsibility of the City via its contractor. Coordination with paving schedules will take place during the design process.
- ▶ Trash pick-up locations at the outside edge of the plaza will be determined as part of the design process.



Parklets



PAY
METER
HERE
↓

11

TOW ZONE
NO
STANDING
PERMITTED
MOVING
VEHICLES ONLY

PARKLETS

Overview

Boston has many vibrant Main Street Districts, which are home to the local businesses that give each neighborhood its unique character. These spaces serve as community gathering places, but in many of them there is actually very little public space for gathering. In Main Street Districts and other areas of Boston with narrow sidewalks and limited access to parks, Parklets can offer new outdoor gathering spaces and bring new activity to the street and nearby businesses.

A Parklet repurposes part of the street, typically one or two parking spaces, into a public space in which people can gather and socialize. In cities across the country, Parklets play an important role in neighborhood placemaking, encouraging community interactions and a vibrant street life.

Parklets introduce new streetscape features such as seating, plantings, art, and bicycle parking on a platform extending into the parking lane of the street. Parklets are typically sponsored by a nearby business or community organization, but Parklets are public and open to everyone, not just customers of a specific business. For table service or private parklets, refer to Outdoor Cafe guidelines (see pg. 21).

A City-sponsored parklet may not become private. If the partner wishes to replace a public parklet with a private one, they will need to independently apply through the Outdoor Cafe permitting process with the Public Improvement Commission.

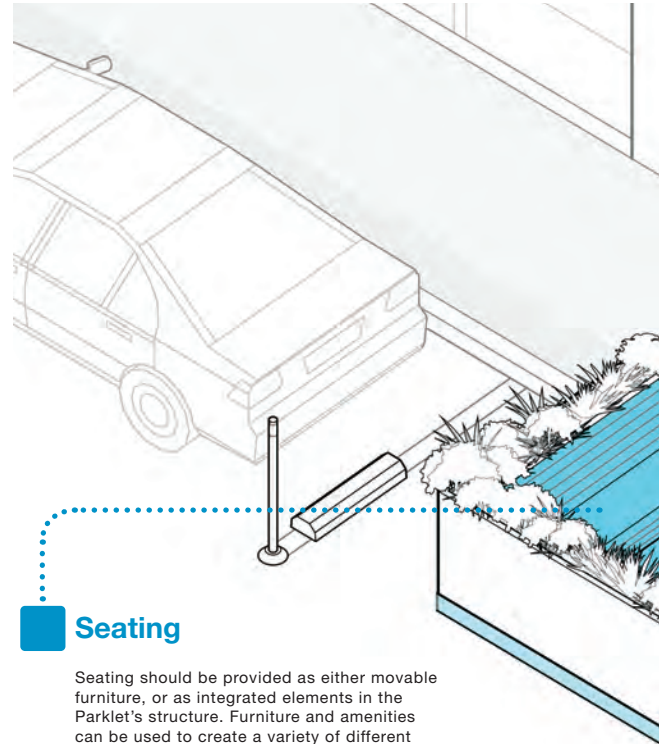
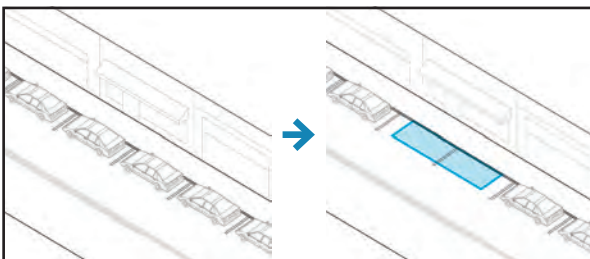

Seating

Seating should be provided as either movable furniture, or as integrated elements in the Parklet's structure. Furniture and amenities can be used to create a variety of different social spaces. Five percent of seating must be accessible for persons with disabilities.

Barrier

A barrier separates the Parklet from the roadway, protecting users from motorists while also defining the space. Barriers with some level of transparency are preferred to provide visual interest.

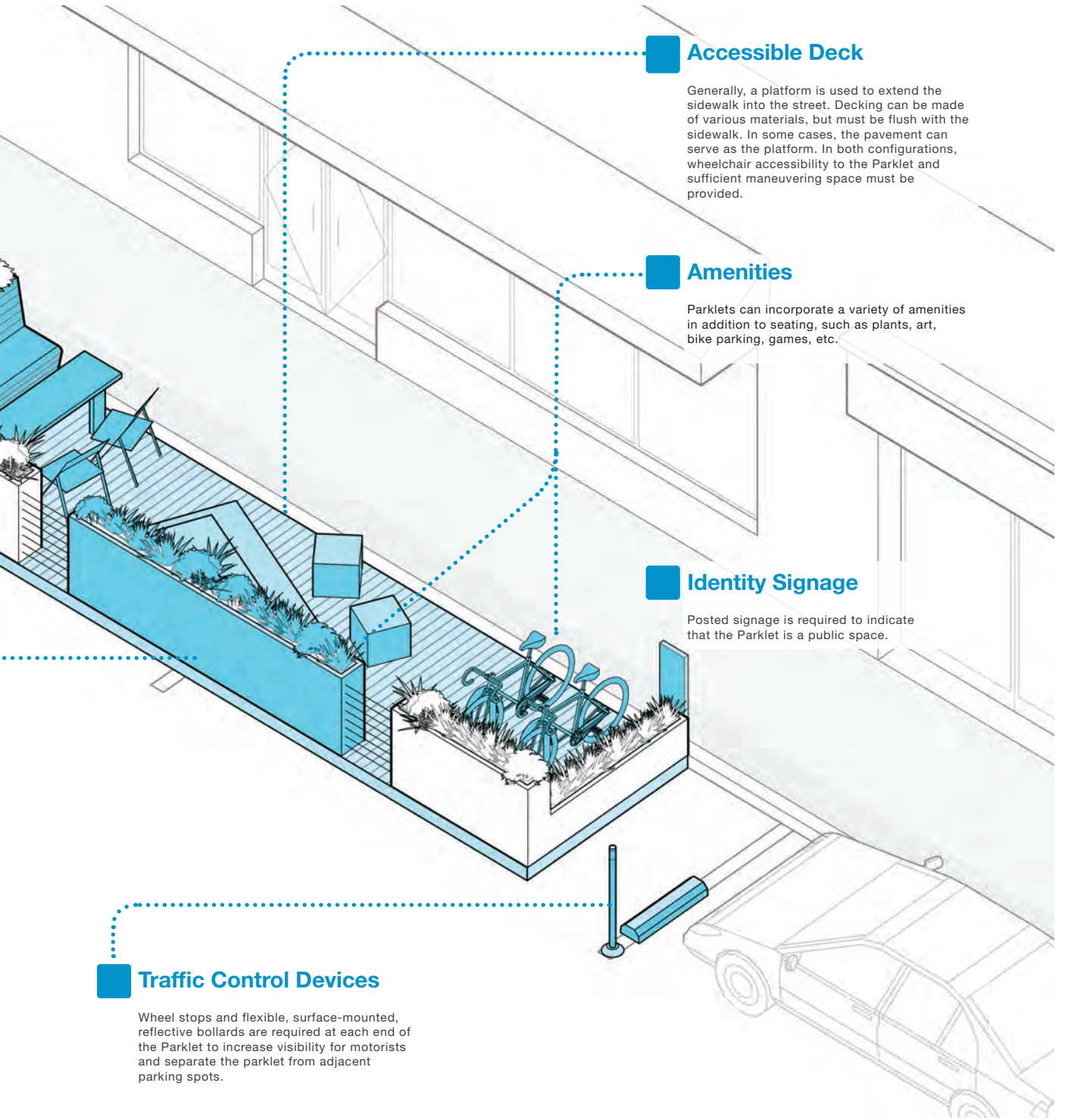
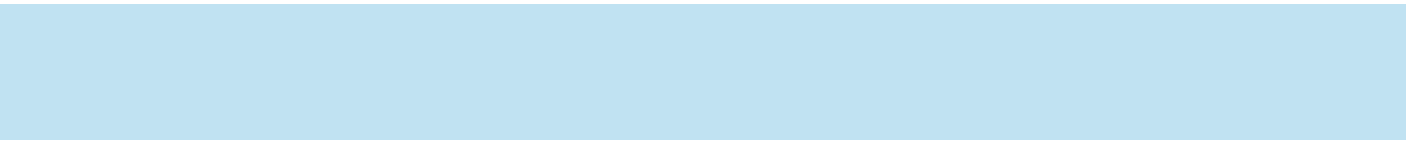

Accessible Deck

Generally, a platform is used to extend the sidewalk into the street. Decking can be made of various materials, but must be flush with the sidewalk. In some cases, the pavement can serve as the platform. In both configurations, wheelchair accessibility to the Parklet and sufficient maneuvering space must be provided.

Amenities

Parklets can incorporate a variety of amenities in addition to seating, such as plants, art, bike parking, games, etc.

Identity Signage

Posted signage is required to indicate that the Parklet is a public space.

Traffic Control Devices

Wheel stops and flexible, surface-mounted, reflective bollards are required at each end of the Parklet to increase visibility for motorists and separate the parklet from adjacent parking spots.

Context and Location Criteria

Parklets are best suited for streets that have relatively narrow sidewalks and no public open space in the immediate vicinity. They are especially well-suited to neighborhood business districts like small Main Street Districts, where there is a concentration of street activity, but retail footprints are smaller, and sidewalks often lack space for benches or outdoor seating. Parklets should be located as close as possible to existing hubs of activity, such as cafes, shops, and other popular destinations. The most successful Parklets are in the center of a business district, and are immediately adjacent to an active ground-floor use.

There are a few types of locations where siting a successful Parklet may be more difficult. Parklets are less well suited for busy arterial streets with heavy or fast-moving traffic. Also, Parklets may serve no real purpose if they are located too close to an existing public open space, such as a park.



General Requirements

Speed Limit	Parklets are permitted on streets regulated at or below the default speed limit of 25 mph.
Street Slope	Parklets are allowed on streets with a running slope of 5% or less.
Public Utilities	Parklets must not block fire hydrants or cover any utility or manhole covers.
Water Drainage	Parklets must not be installed over street drains unless accommodations for water flow are made.
Existing Public Right of Way	Parklets must not obstruct other street furniture, plantings, or signage. Electrical cords may not run across the public right of way from a partner establishment to a Parklet.
Paving Schedule	Parklets should not be installed in locations scheduled for resurfacing or utility work within 8 months of installation.
Assembly and Disassembly	Parklets must be easy to assemble on site and dismantle for storage or in case of emergency hazard situations. Components must be transportable by a standard pickup truck when disassembled.



Top: Parklet in Roslindale, Boston
Bottom: Parklet in San Francisco

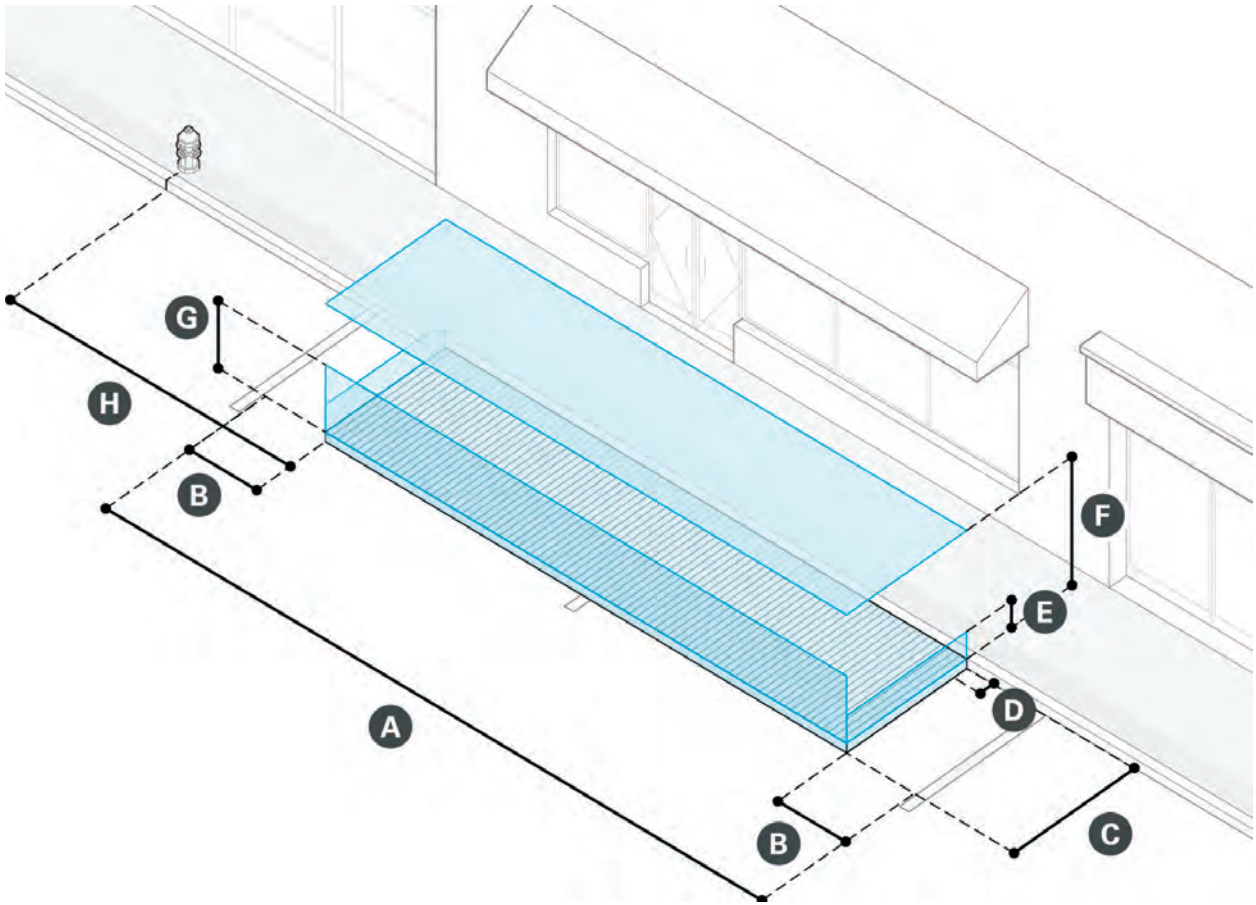

An accessible curb ramp and platform can also be used to create a Parklet directly on the pavement:

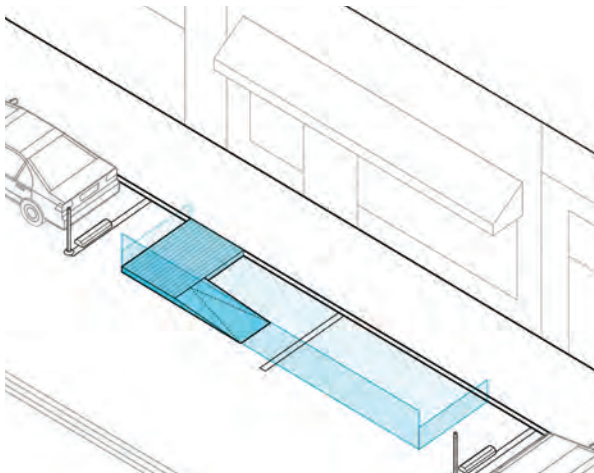

Design and Placement

A	Typical width occupied along street	2 parking spaces
B	Distance from platform to wheel stop	3'
C	Maximum parklet width from curb	7'
D	Platform is flush with curb and maintains curblines drainage	
E	Minimum side edge height	17"
F	Minimum overhead clearance	80"
G	Street edge height	36–42"
H	Minimum distance from fire hydrant to Parklet	15'

Application and Implementation Process

Each year the City may fund one to two Parklets. Additional Parklets may be implemented if fully funded by community partners. The process for privately-funded Parklets is the same, except that the partner must provide their own design consultant and contractor.

The application process outlined below is only for Boston Transportation Department (BTD) sponsored Parklets and may not be used for privately managed cafe seating applications. Guidelines for Outdoor Cafes can be found on page 21.

1 Nominate a location for a Parklet and submit application to BTD

Application guidelines can be found at www.boston.gov/publicrealm.

Applications must include:

- ▶ street-level photos of the site to describe its existing conditions, and an aerial image diagram to indicate the proposed Parklet location.
- ▶ letters of support from abutters and local organizations, such as resident associations and business groups

2 Initial review by the City

Applications will be evaluated and selected based on criteria which will be available at www.boston.gov/publicrealm.

3 The City's on-call design consultant will work with the community partner to design the Parklet

- ▶ Applicant should expect to meet with BTD and the City's on-call consultant up to three times.
- ▶ Applicant is strongly encouraged to work with local artists and designers to contribute to the development of the Parklet design.

4 Proposal will be reviewed through a public process determined by the City and adjusted based on the feedback

5 The City's on-call design consultant presents to Public Improvement Commission (PIC) for administrative approval

6 Memorandum of Understanding (MOU)

Successful applicant becomes the official Parklet Partner by signing an MOU with the Public Improvement Commission (PIC). A sample is available at www.boston.gov/publicrealm.

7 Design installed by City contractor

Parklets will be in place seasonally.

Community Partner and City Roles

The long-term success of a Parklet will depend on community partners. Successful Parklets are embraced by those who use them, and are supported by community partners that provide “eyes on the Parklet” and have a true sense of ownership.

Parklet Partner

Regular Maintenance

- ▶ Cleaning, trash removal, and plant watering are the responsibility of the Parklet Partner.

Day-to-Day Management

- ▶ Daily setup and breakdown of any items that cannot be left out overnight are the responsibility of the Parklet Partner.
- ▶ Selection of plaza furnishings should take into consideration the level of daily management required.

City

- ▶ The City is responsible for dismantling the Parklet and storing it during the winter.
- ▶ The City is responsible for maintaining wheel stops and bollards.
- ▶ The City is responsible for reinstallation.



Outdoor Cafes



OUTDOOR CAFES

Overview

From spring through fall Boston has thriving outdoor cafes visible on the streets of Downtown, Back Bay, the South End, along the Greenway, and increasingly in neighborhood squares. Outdoor Cafes add activity and vibrancy to Boston's city streets, while seasonally providing an expanded space for businesses and a desirable experience for patrons.

Outdoor Cafes can take on a variety of configurations, but each must be limited in width to the frontage of the business with which it is associated. In addition to locating an Outdoor Cafe against a business façade, it is permissible to place an Outdoor Cafe on the sidewalk along the curb or on the street in a former parking space.

Outdoor Cafes are typically privately funded and maintained, and must clearly delineate the boundary between public and private areas, with an enclosure on all sides. An Outdoor Cafe must not obstruct public access along the sidewalk, and must provide accessible paths both along the sidewalk for the public, and between the restaurant and the outdoor seating for patrons and employees.



Outdoor cafe on Boylston Street in Boston

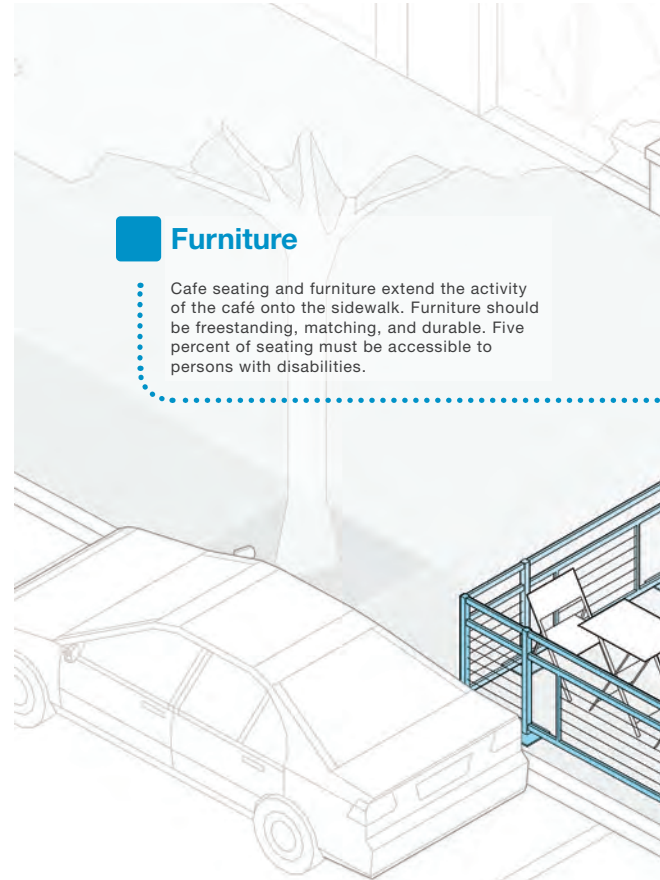

Furniture

Cafe seating and furniture extend the activity of the café onto the sidewalk. Furniture should be freestanding, matching, and durable. Five percent of seating must be accessible to persons with disabilities.

Enclosure

An enclosure is required on all sides of an Outdoor Cafe to separate it from the public right-of-way. Different types of enclosures can be used, such as fencing, bollards, or plant containers, but they must provide visibility between the seating area and the sidewalk. The enclosure must be attached to the ground where possible and must be cane-detectable.

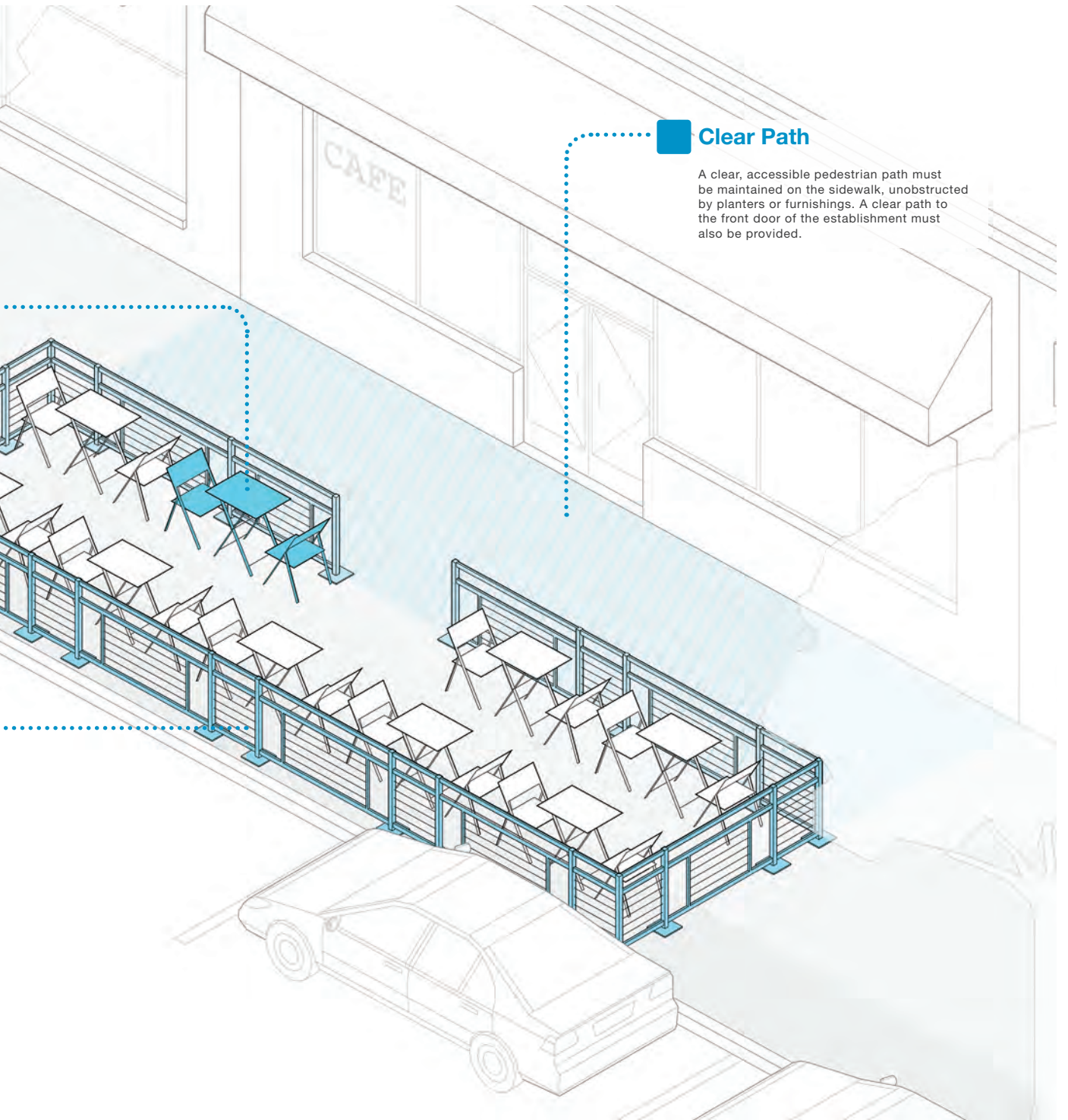
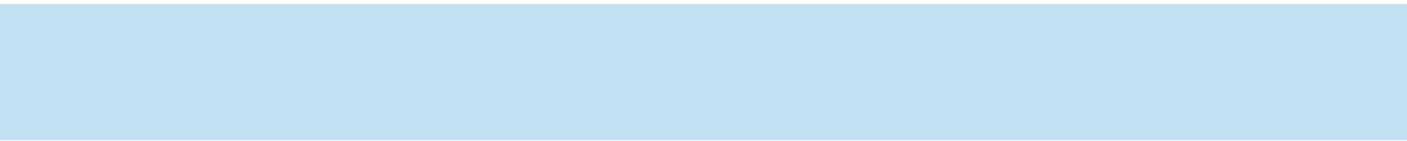

Clear Path

A clear, accessible pedestrian path must be maintained on the sidewalk, unobstructed by planters or furnishings. A clear path to the front door of the establishment must also be provided.

Context and Location Criteria

Outdoor Cafes can be welcome amenities on many different kinds of streets, in all neighborhoods throughout the City. On streets with wide sidewalks, an Outdoor Cafe located adjacent to the building is appropriate **A**.

In some locations the sidewalk width between the building and the curb may be wide enough for an Outdoor Cafe, but trees or street furniture closer to the curb may make it more appropriate to locate the clear path along the building façade. In these cases, an Outdoor Cafe is best located adjacent to the curb, **B** in order to create less disruption for pedestrians.

In many neighborhoods, sidewalks are too narrow to accommodate cafe seating adjacent to either the building or the curb. Yet, in many of these neighborhoods the businesses themselves are smaller and could benefit from expanded seating. Therefore, the City has expanded the options for Outdoor Cafes to allow them to be located on the street adjacent to the sidewalk. **C** In these cases, one or more on-street parking spaces can be converted to an Outdoor Cafe that is associated with the adjacent business. Outdoor Cafes located on the street are regulated in the same way as those on the sidewalk. Public Parklets may look similar to on-street Outdoor Cafes, but Parklets have lower permitting requirements, are open to all, and do not allow table service from any one restaurant or business.

General Requirements

Public Utilities	Outdoor Cafes must not block a fire hydrant.
Existing Public Right of Way	Outdoor Cafes cannot obstruct other street furniture, plantings, or signage unless permitted. Electrical cords may not be laid across the public right of way from a partner establishment to an Outdoor Cafe.
Assembly and Disassembly	All components of an Outdoor Cafe must be able to be dismantled for storage during periods of non-use.
Seating	Five percent of seating must be accessible to persons with disabilities.
Water Drainage	On-street outdoor cafes must not be installed over street drains unless accommodations for water flow are made.
Barriers	Barriers must be fixed and effectively immovable (bolted posts, planters, etc.).

A Façade Seating

Cafe seating adjacent to a building must provide a clear entry path through the seating area to the entrance of the cafe.

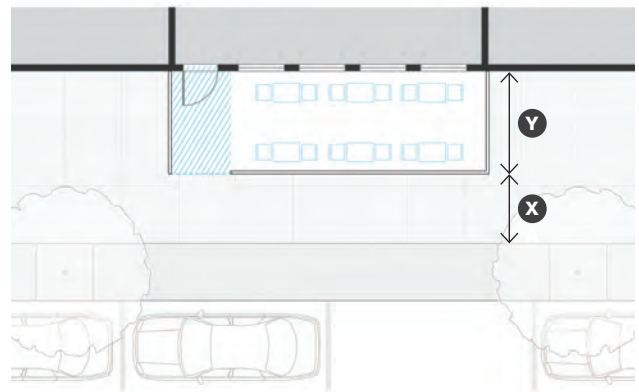

Clear Path Requirements

X	Pedestrian Clear Path	The minimum clear pedestrian path outside of the proposed seating area shall conform with the Pedestrian Zone “preferred and minimum widths for sidewalk zones” as noted in the Boston Complete Streets Guidelines.
Y	Seating Area Width	May not exceed 50% of total sidewalk width

For on-street Outdoor Cafes, see [Parklet Design Guidelines](#) for additional requirements (pg. 13).

B Curbline Seating

Cafe seating along the curb must provide a proper enclosure on all sides of the seating area. Cords and furniture cannot obstruct the clear path between the establishment and the seating area.

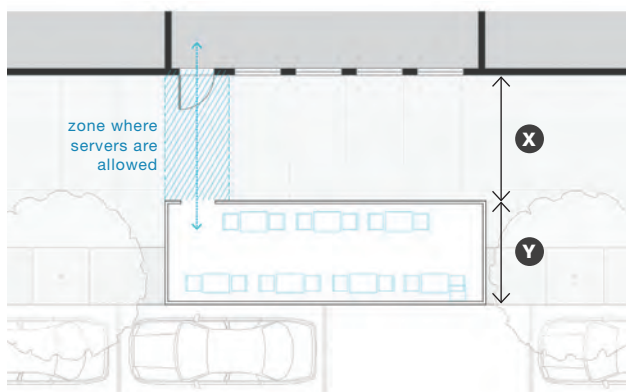

C Roadway Seating

The length of a seating area on the street cannot exceed three parking spaces. For other design requirements for on-street seating see Parklet Design Guidelines (pg. 13).

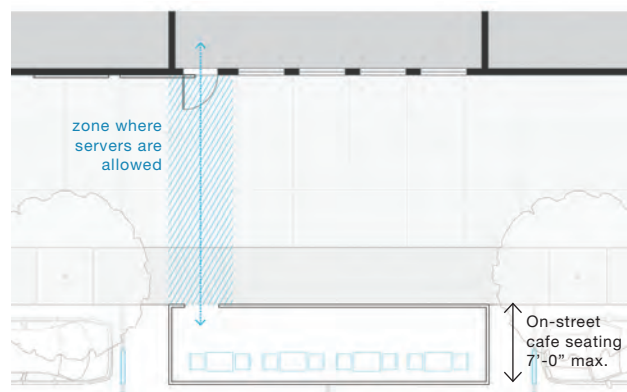

A/C Façade and Roadway Seating

Building-adjacent seating and on-street seating can be combined to create a large outdoor seating space with a clear pedestrian path running between adjacent and on-street areas.

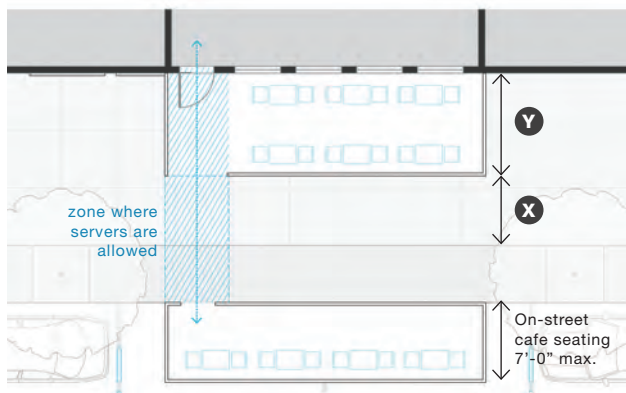

B/C Curbline and Roadway Seating

A combination of curbside seating and on-street seating can be used to create an expanded outdoor seating area along the street.

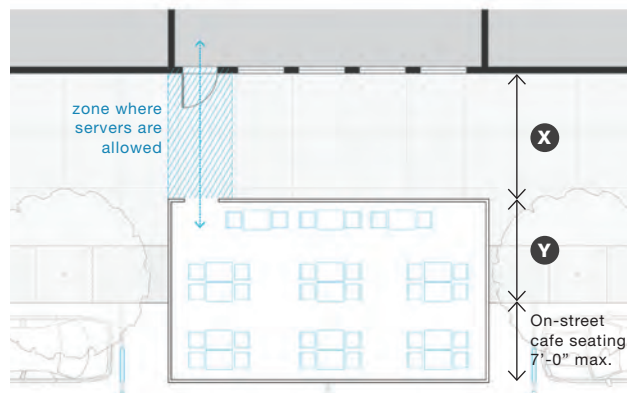

Design Guidelines

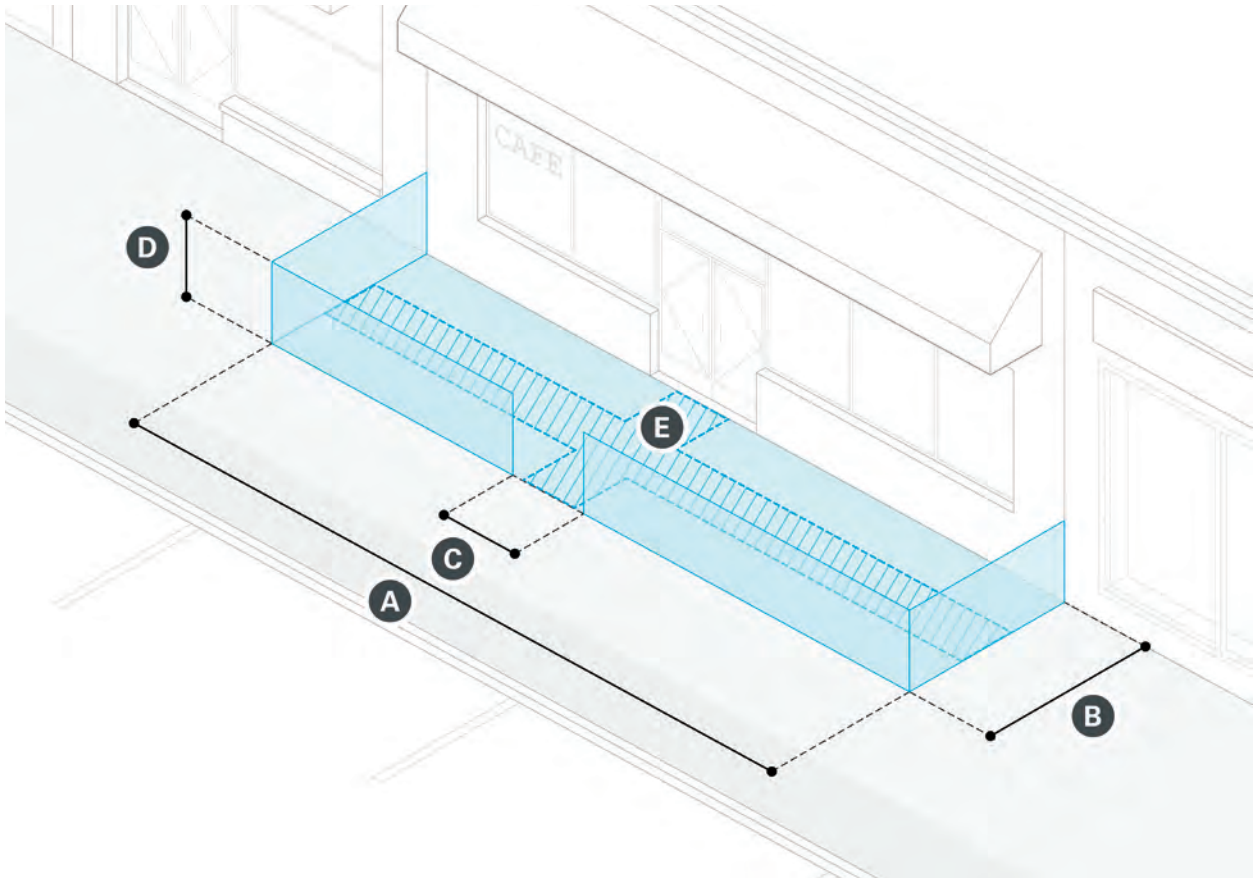

Façade Seating: Design and Placement

A	Seating Area Length	May not exceed beyond restaurant facility
B	Seating Area Width	May not exceed 50% of total sidewalk width
C	Entry Threshold	48" minimum clear zone at each entry
D	Enclosure Height	Fencing or chain and bollards: 36"–48" Planter boxes: 18"min.–24"
E	Circulation	36" wide minimum circulation path to entrance

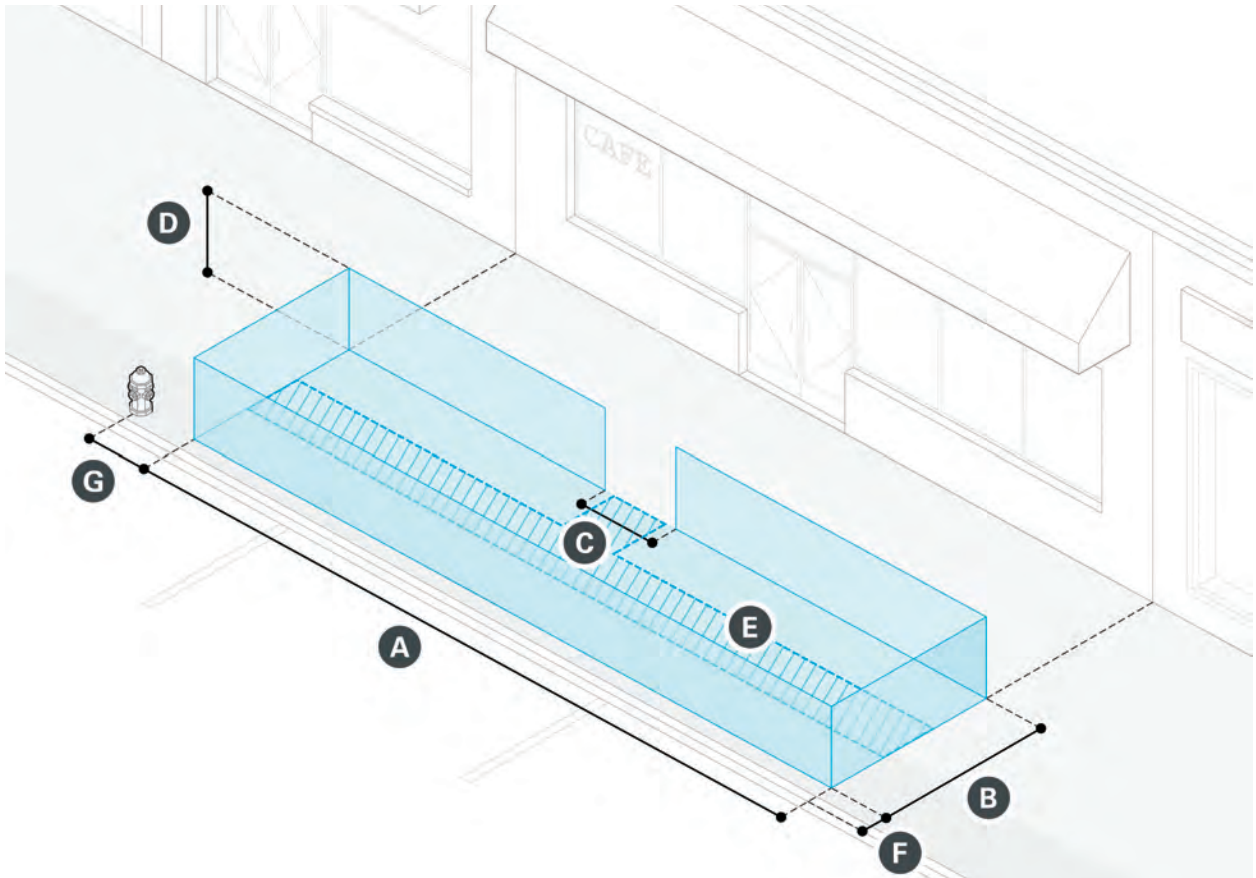

Curbside Seating: Design and Placement

For on-street outdoor seating see [Parklet Design Guidelines](#) (pg. 13).

A	Seating area length	May not exceed beyond restaurant facility
B	Seating area width	May not exceed 50% of total sidewalk width
C	Entry threshold	48" minimum clear zone at each entry
D	Enclosure height	Fencing or chain and bollards: 36"–48" Planter boxes (non-street sides): 18"–24"
E	Circulation	36" wide minimum circulation path
F	Without parking meter	On curb edge
	With parking meter	18" minimum from parking meter
G	Distance from fire hydrant	3' minimum

Application and Implementation Process

Outlined below is general cafe guidance. For complete procedure, design guidelines, submission requirements, or additional information visit www.boston.gov/PIC or email PIC@boston.gov.

1 Prepare plans and documentation

- ▶ **Photograph(s)** provide eye-level photos of proposed location.
- ▶ **Plan and Elevation Drawings** prepared by a Massachusetts Professional Engineer (PE) or Professional Land Surveyor (PLS) show the site context and cafe layout with enclosures; dimension the proposed seating area and sidewalk clearances; and indicate any vertical obstructions.

2 Submit plans to private utility companies and the following public agencies for review:

- ▶ Boston Transportation Department (BTD)
- ▶ Inspectional Services Department (ISD)
- ▶ Boston Water and Sewer Commission (BWSC)
- ▶ Public Works Department (PWD)
- ▶ Mayor’s Commission for Persons with Disabilities
- ▶ Boston Parks and Recreation Department
- ▶ Boston Planning and Development Agency
- ▶ Mayor’s Office of Neighborhood Services
- ▶ Boston Landmarks Commission (if applicable)
- ▶ Contact PIC for additional agency and utility contacts.

3 Begin drafting License, Maintenance, and Indemnification (LMI) agreement and consult with:

- ▶ Public Improvement Commission (PIC) Staff
- ▶ Public Improvement Commission’s Legal Counsel
- ▶ Public Works Permitting Division (to establish the license fees)

4 Submit full submission to the PIC for review; submission includes:

- ▶ plans
- ▶ petition
- ▶ responses from all public agencies listed in step (2)
- ▶ utility company delivery receipts
- ▶ Manager’s Certificate or Certificate of Authority
- ▶ City Licensing Board documentation
- ▶ letter(s) from building owner and/or condo association
- ▶ copy of rental lease (if applicable)
- ▶ letter(s) of support from neighborhood association(s)
- ▶ areaway/vault letter (if applicable)
- ▶ Certificate of Insurance

5 Appear at a PIC Hearing under “New Business” and present the project

6 Make any revisions or amendments to the project as requested at the “New Business” Hearing

7 Appear at a PIC Hearing under “Public Hearing,” at which the PIC will review changes and vote on the petition

8 Upon approval, provide PIC staff one copy of the final plans on Mylar and receive the necessary permits

9 Applicant receives a license agreement for the use of public space and installs the cafe seating

Applicants may need the help of professional services to meet the engineering drawings (1) and LMI requirements (3).

Owner Responsibilities

Outdoor Cafes promote the use and enjoyment of public space. The success of an Outdoor Cafe as both a street feature and a business feature depends on the owner.

Regular Maintenance

- ▶ Cleaning, trash removal, and plant watering are the responsibility of the owner.

Day-to-Day Management

- ▶ Daily setup and breakdown of any items that cannot be left out overnight are the responsibility of the owner.
- ▶ Furniture should be secured together with cable and locks; furniture should not be stacked or locked to other objects, such as street lights, street trees, or the enclosure.

Temporary Removal

- ▶ In winter, all furniture and enclosures must be removed and stored inside the restaurant facility or off site, and any penetrations to the ground surface must be capped or filled.
- ▶ Cafe may be required to be removed for construction, repair, or utility work.

License Fees

- ▶ Cafe owners are required to pay an annual license fee.



Temporary Art: Street Murals



TEMPORARY ART: STREET MURALS

Overview

Street Murals convert parts of streets into public art installations, showcasing the creativity and input of local artists and residents. Street Murals themselves activate the public realm, and the process of creating them encourages communities to work together to create vibrant art projects in their neighborhoods. Street Murals take advantage of our most extensive public spaces—streets—to bring more art into daily life, contributing to a sense of place, and of neighborhood identity and pride.



Top: Mid-block mural in Somerville

Bottom: Intersection mural in San Francisco, CA



Top and Bottom Right: Mid-block mural in Allston, Boston
Bottom Left: Street mural on Elmhurst Street, Boston

Context and Location Criteria

Street Murals are best suited to neighborhood residential streets. Murals can be located mid-block or within intersections. A mural can take on various designs, but should not include any colors or shapes that could be perceived as traffic control indicators, and thus, confuse people about the appropriate path of travel. The design and installation of a mural should be collaborative and involve community members and local residents.

General Location Criteria

Murals can be located only on residential streets and streets classified as “local” according to the federal functional classification system.

Designs should avoid pedestrian paths of travel and should not impact existing street parking or traffic control indicators, such as crosswalks, lane lines, regulatory signs, etc.

Pavement must be in good condition.

Murals should not be installed in locations scheduled for resurfacing or utility work within 3 months of painting.

Design Criteria

Designs should not include any shapes or colors that could be perceived as traffic control indicators, or be mistaken for directions to the roadway user or pedestrian.

Designs should not include shapes or color contrast that would confuse persons with vision impairment.

Colors must be non-retro-reflective and must not resemble existing traffic control devices.

Designs should not invite pedestrians to linger or be distracted in the street.

Designs should not include words or universally recognized symbols, logos, any trademarked materials, or advertisements.

Paint must be skid resistant.



Street murals in New York City, NY

Possible Mural Locations

Mid-block

Different types of streets can be appropriate locations for mid-block murals. Neighborhood Residential and Shared Streets are the most typical locations for mid-block murals. Murals in higher-traffic locations will need more frequent repainting. See more on Neighborhood Residential and Shared Streets in the Boston Complete Streets Guidelines (<http://bostoncompletestreets.org/guidelines>).



Intersections

Murals in intersections are most appropriate on lower-volume streets with no traffic signals—in particular, Neighborhood Residential and Shared Streets.

- ▶ Designs should have a small enough coverage area to avoid wear from turning vehicles.
- ▶ Any artistic design within an intersection must not indicate to pedestrians, cyclists, or drivers a path of travel that is contrary to the existing or traditional route.
- ▶ Designs must not interfere with crosswalks.
- ▶ There should not be lines, resembling lane markings, that indicate a path of travel—unless they reinforce the expected path of travel.

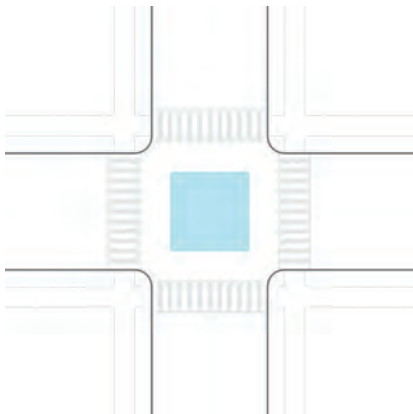

Painted curb extensions at intersections

Painted curb extensions can help calm turning traffic and increase visibility for pedestrians, but should not encourage pedestrians to stand in the street while waiting to cross.

- ▶ Any artistic design should increase visibility for pedestrians and drivers.
- ▶ The painted curb extension must look distinct from the sidewalk, and should not suggest that the painted curb extension is part of the sidewalk.

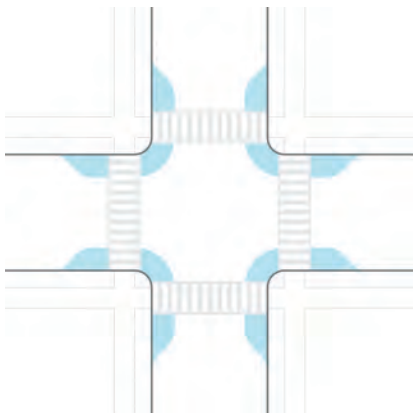

Application and Implementation Process

1 Submit a Boston Art Commission (BAC) Public Art & Design Application available at the link below

Application guidelines can be found at www.boston.gov/publicrealm.

Application should include:

- ▶ sketches or renderings of the mural in the context of the street to communicate size and scale
- ▶ photos and aerial image of the proposed location(s)
- ▶ CV/resume of the artist involved (if applicable)
- ▶ letter(s) of support from neighbors, the funder, project partners, and/or other local businesses

2 BAC and Boston Transportation Department (BTD) review the proposal

3 Successful applicant signs a Street Painting License

A sample is available at www.boston.gov/publicrealm.

4 Apply online for a Street Closure Permit from BTD and the Public Works Department (PWD)

More information is available at www.boston.gov/publicrealm.

5 Mural is installed by the community/ artists

Installations are intended to be temporary; applicant may reapply for permits to maintain the design after 18 months.

Community Partner Role

Street Murals not only serve as neighborhood public art installations, but also, foster inclusive and vibrant communities. The success of a Street Mural to enliven a neighborhood depends on the community partner. Individuals and organizations can apply to serve as the Community Partner to create a street mural collaboratively with artists, residents, neighbors, and volunteers to create art pieces that transform the places in which they live.

It is the community partner's role to install a Street Mural. The implementation process builds relationships within the community, and community partner's should involve neighbors and local residents in the mural's design and installation.

The installation of a mid-block Street Mural in Allston, Boston





Photo Credits

P iv: © MP Boston

P 3: © Irene Figueroa-Ortiz

P 4: © MP Boston

P 7: NYCDOT/Creative Commons

P 8: © Utile

P 12: © Jessica Robertson

P 16: (top) City of Boston/Public Domain

P 16: (bottom) © NACTO

P 20: MassDOT/Creative Commons

P 22: © Utile

P 30: © Galen Mook

P 32: (top) © Andrew Nahmias

P 32: (bottom) SDOT/Creative Commons

P 33: (top) © Galen Mook

P 33: (bottom left) © Paul Malkemes

P 33: (bottom right) © Galen Mook

P 34: (top) NYCDOT/Creative Commons

P 34: (bottom) NYCDOT/Creative Commons

P 37: © Galen Mook

P 38: © KZLA and Christian Phillips Photography

